

HARDSCAPE ELEMENTS

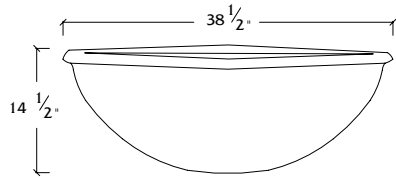

P-WOK4
Large Wok

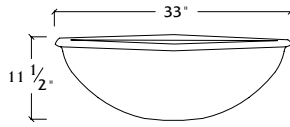

P-WOK3
Medium Wok

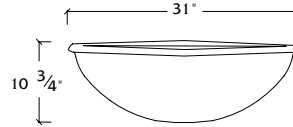

P-WOK2
Small Wok

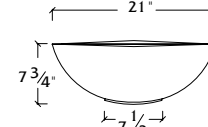

P-WOK1
Mini Wok

All Woks Manufactured With 3/4" Drain Hole

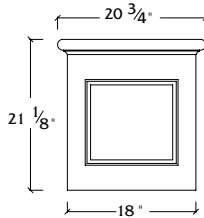
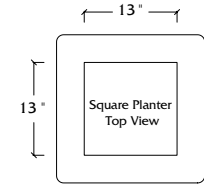

P-SQ
Square Planter

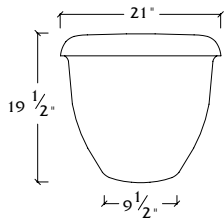

P-SJ
Small Planter

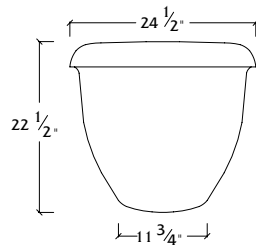

P-MJ
Medium Planter

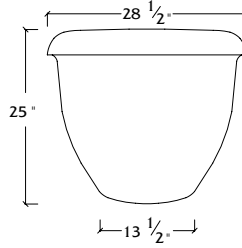

P-LJ
Large Planter

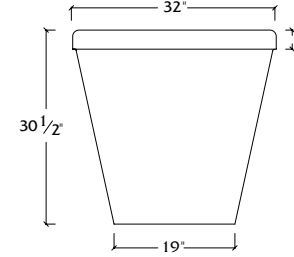

P-GT
Giant Planter

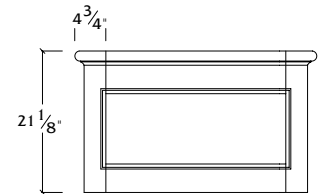

P-RC
Rectangle Planter

Available in various lengths

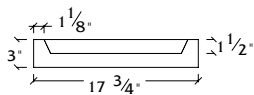

P-SSJ
Small Saucer

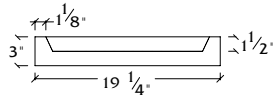

P-SMJ
Medium Saucer

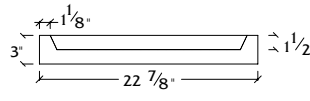

P-SLJ
Large Saucer

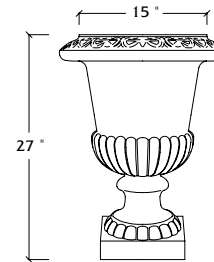

P-DC
Decorative Planter

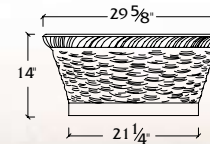

P-BW
Basket Weave

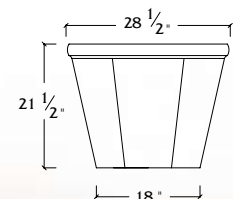

P-HX
Hexagon Planter

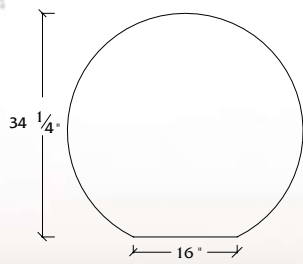

S-36
Large Sphere

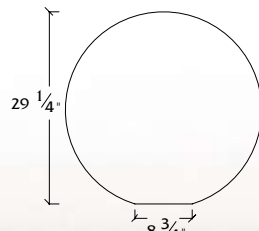

S-30
Medium Sphere

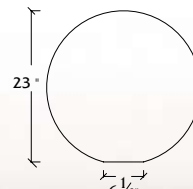

S-24
Small Sphere

HARDSCAPE ELEMENTS

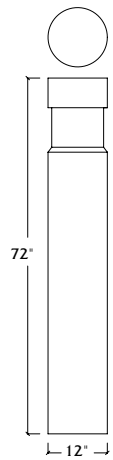

Bollard-1

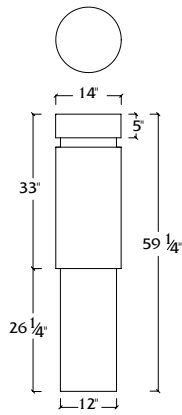

Bollard-2

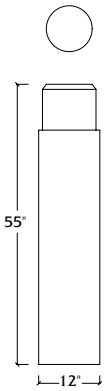

Bollard-3

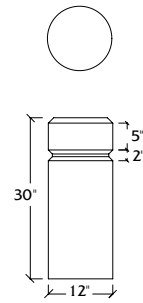

Bollard-4

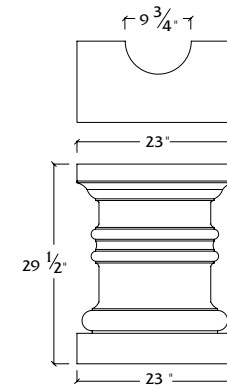

**RC-10-24
Table Bottom**

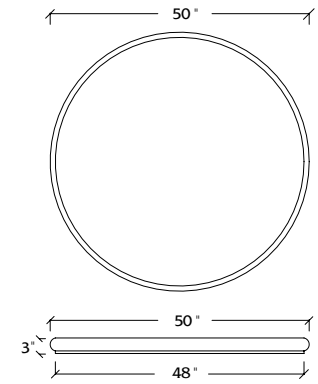

**RD-T
Table Top**

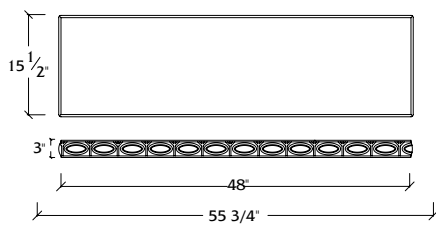

**B-S-48*
B-S-55*
Bench Seat**

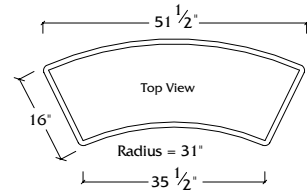

*Detail wraps edge

**B-C-50*
Bench Seat**

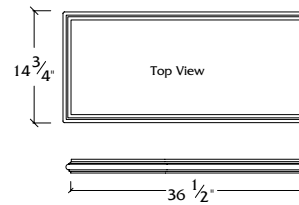

**B-S-35
Bench Seat**

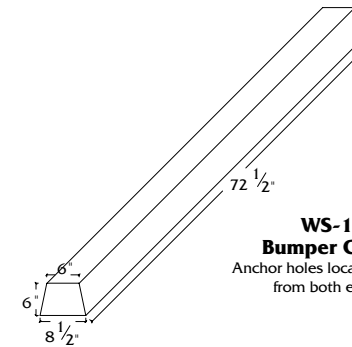

**WS-1
Bumper Curb**
Anchor holes located @ 4"
from both ends

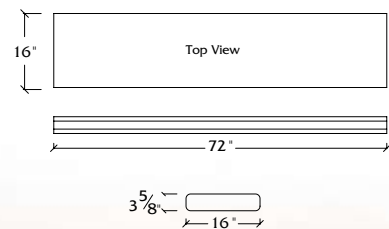

**M-16-6
Bench Seat**

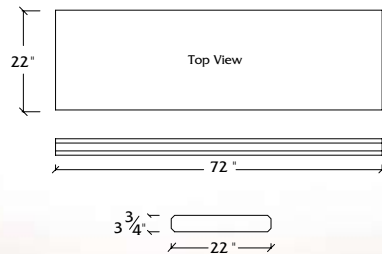

**M-20-6
Bench Seat**

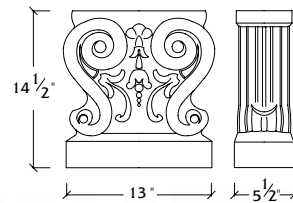

**L-12
Bench Leg**

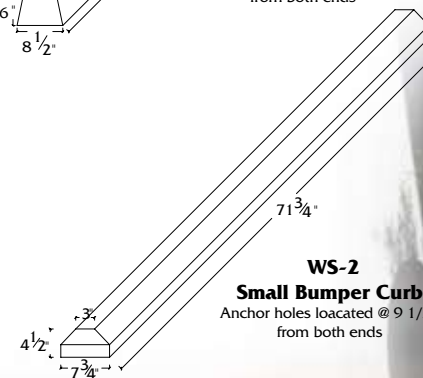

**WS-2
Small Bumper Curb**
Anchor holes located @ 9 1/2"
from both ends

