

SIDE VIEW

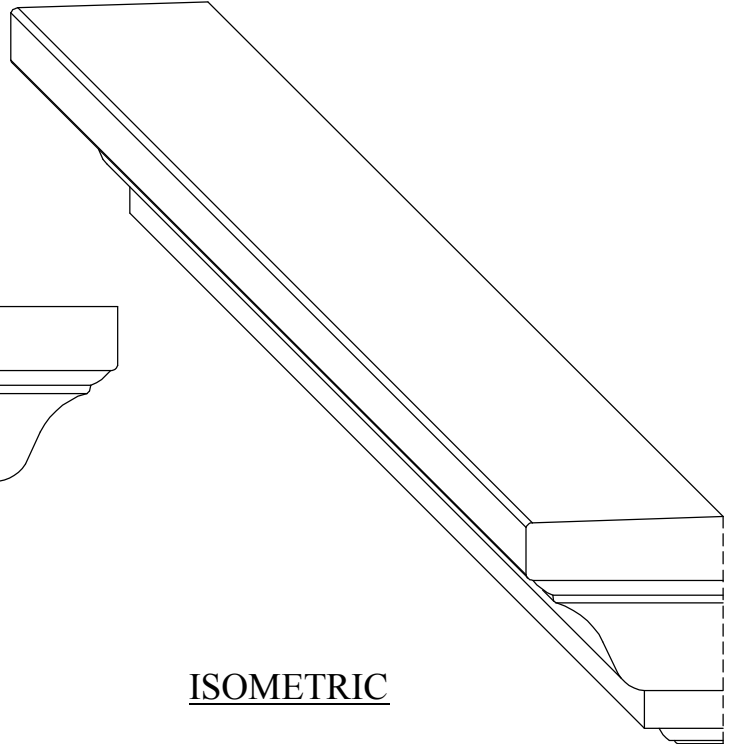

ISOMETRIC

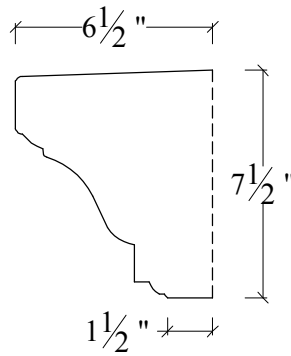

PROFILE

RIGHT RETURN MOLDING

INDICATES UNFINISHED SURFACE

PIECE ID: M-8-4RR	QUANTITY:	COLOR:	FINISH:
PROJECT NAME:		WEIGHT: ~ 68 LBS.	
LOCATION:		MIX: C-B (CONCRETE)	
CONTACT:			
DETAIL:			
LIFTING DEVICES:			
ATTACHMENT:			WWW.MESAPRECAST.COM