

TOP VIEW

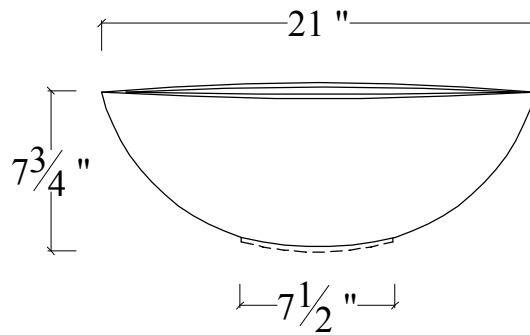

SIDE VIEW

-----  
INDICATES UNFINISHED SURFACE

**PLANTER**

PIECE ID: <b>P-WOK1</b>	QUANTITY:	COLOR:	FINISH:
PROJECT NAME:		WEIGHT: ~ LBS.	
LOCATION:		MIX: C-A (CONCRETE)	
CONTACT:			
DETAIL:			
LIFTING DEVICES:			
ATTACHMENT:			<a href="http://WWW.MESAPRECAST.COM">WWW.MESAPRECAST.COM</a>