

TOP VIEW

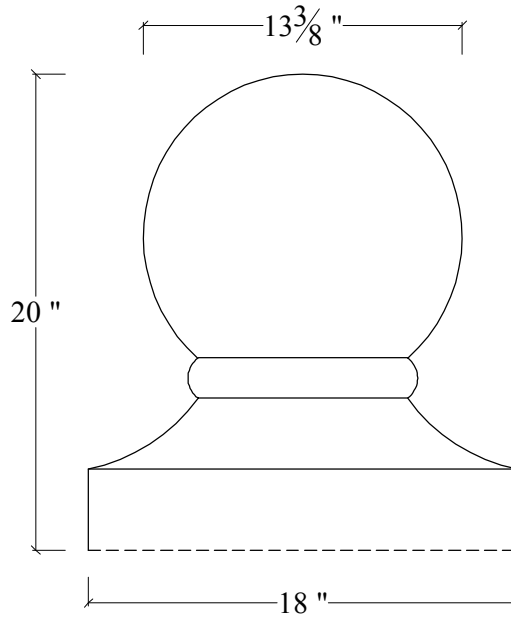

SIDE VIEW

INDICATES UNFINISHED SURFACE

PIER CAP

PIECE ID: SB-14	QUANTITY:	COLOR:	FINISH:
PROJECT NAME:		WEIGHT: ~ LBS.	
LOCATION:		MIX: C-A (CONCRETE)	
CONTACT:			
DETAIL:			
LIFTING DEVICES:			
ATTACHMENT:			WWW.MESAPRECAST.COM